

GPS+GSM+WIFI Combination Antenna JCE046

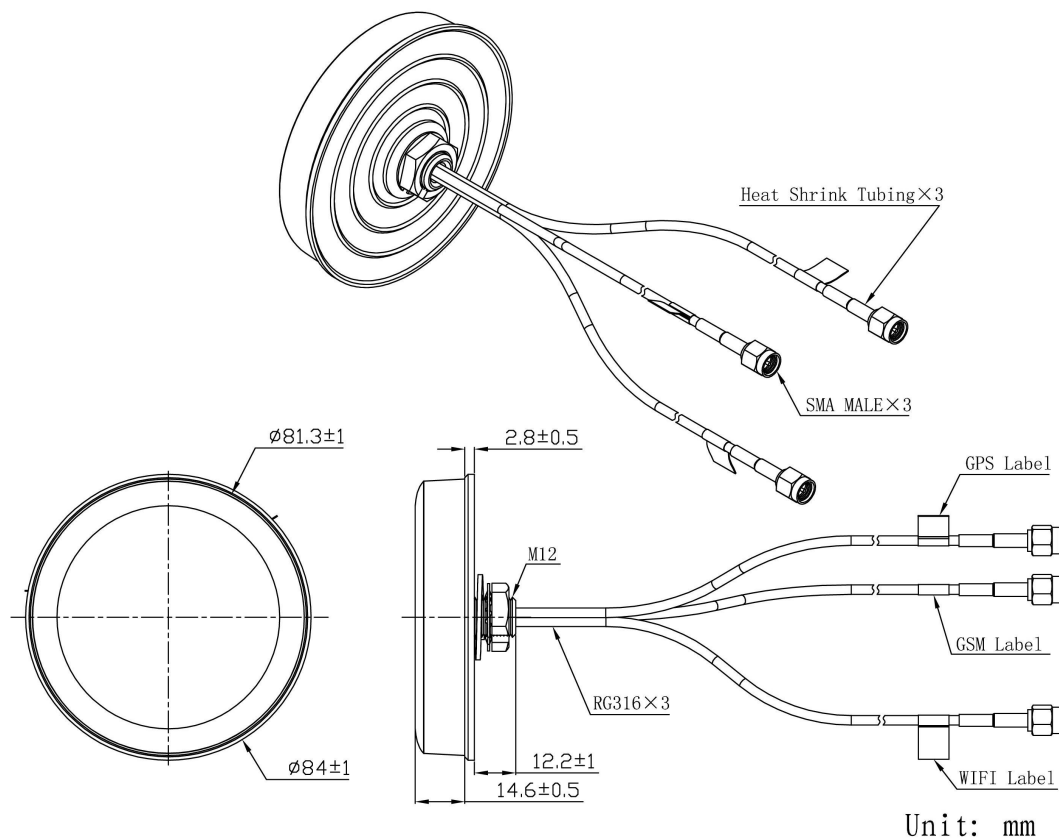

DIMENSIONS



JIAXING JINCHANG ELECTRONIC TECHNOLOGY CO.,LTD

Add: 398#,Zhenye Road, South Street, Jiaxing, Zhejiang, China

Http:// www.jinchanggps.com

E-mail:jcgps@vip.163.com

Tel: 86-0573-83692157/83692605/83958637 Fax:86-0573-83958635

SPECIFICATIONS

Item		Specifications	
GPS Antenna	Dielectric Antenna	Center Frequency	1575.42±3MHz
		Band Width	CF±5MHz
		Polarization	RHCP
		Gain	2dBic (Zenith)
		V.S.W.R	<1.5
		Impedance	50Ω
		Axial Ratio	3dB (max)
	LNA	Gain	28±2dB
		Noise Figure	<1.5dB
		V.S.W.R	<2.0
Supply Voltage		2.2~5V DC	
Current Consumption		<15mA	
GSM Antenna		Frequency Range	824~960MHz/1710~2170MHz
		V.S.W.R	<2.0
		Polarization	Linear
		Gain	2.0dBi
		Impedance	50Ω
WIFI Antenna		Frequency Range	2400~2483.5MHz
		Band Width	83.5MHz
		Polarization	Linear
		Gain	3dBi
		V.S.W.R	<2.0
		Impedance	50 Ω
Mechanical		Cable	RG174
		Connector	SMA/MCX/FAKRA or others
		Material	ABS
		Mounting Method	Screw
Environmental		Operating Temperature	-40°C~+85°C
		Relative Humidity	Up to 95%

JIAXING JINCHANG ELECTRONIC TECHNOLOGY CO.,LTD

Add: 398#,Zhenye Road, South Street, Jiaxing, Zhejiang, China

Http:// www.jinchanggps.com

E-mail:jcgps@vip.163.com

Tel: 86-0573-83692157/83692605/83958637 Fax:86-0573-83958635

	Ingress Protection	IP65~IP66 (exclude cable outlet)
	Vibration	10 to 55Hz with 1.5mm amplitude 2hours
	Environmentally Friendly	ROHS Compliant

Radiation Pattern

GPS Antenna

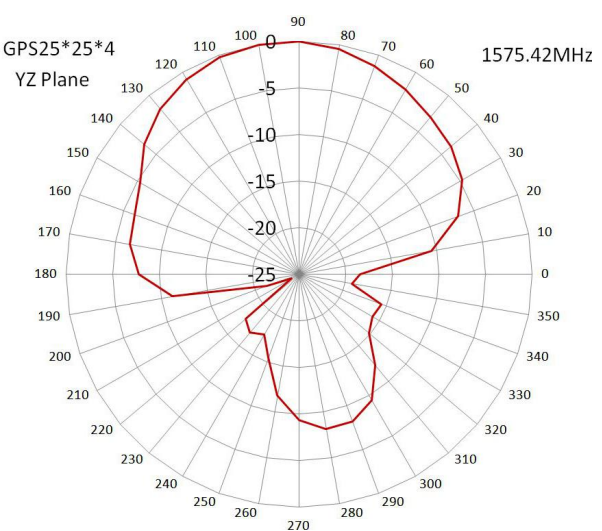
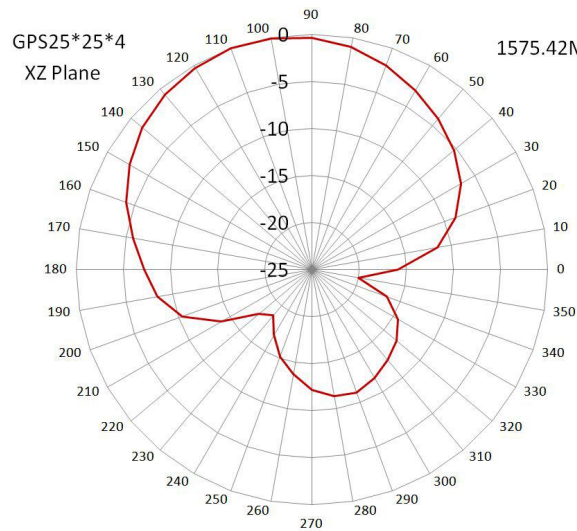
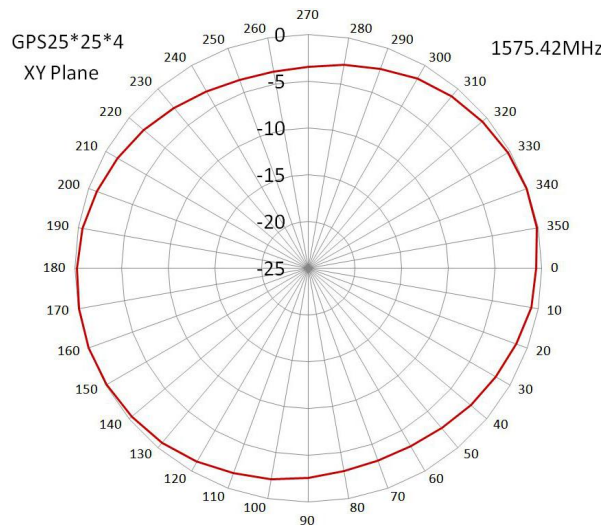

GSM Antenna

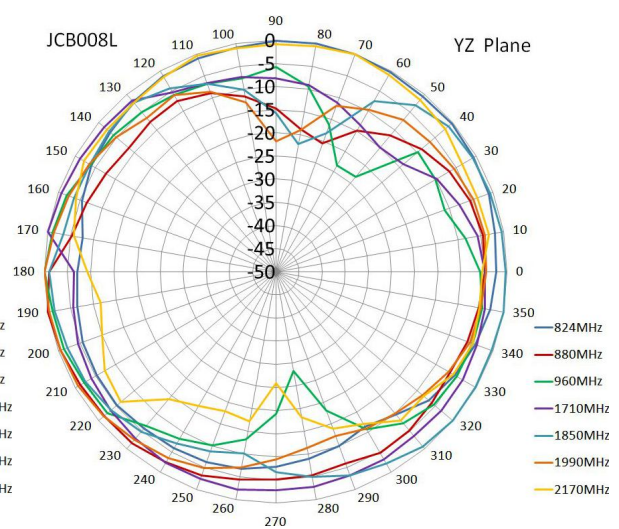
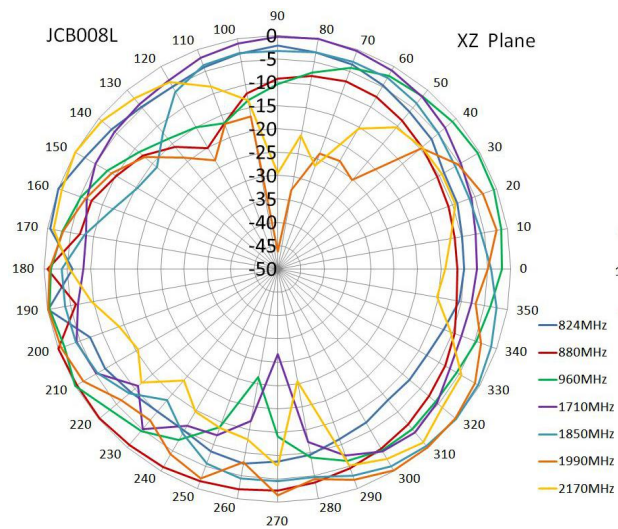
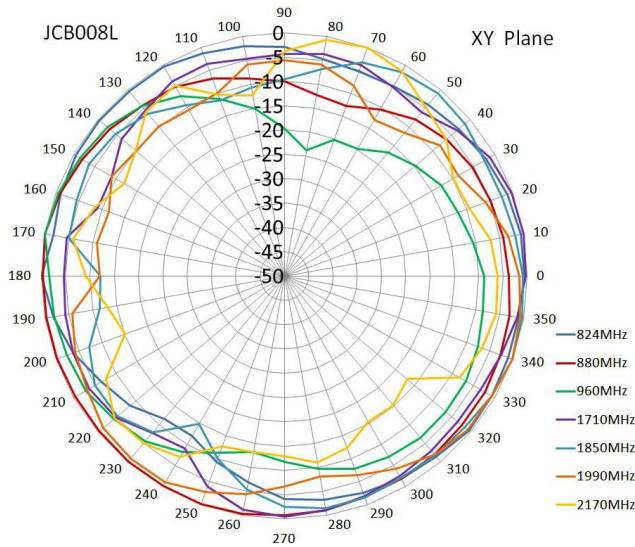

WIFI Antenna

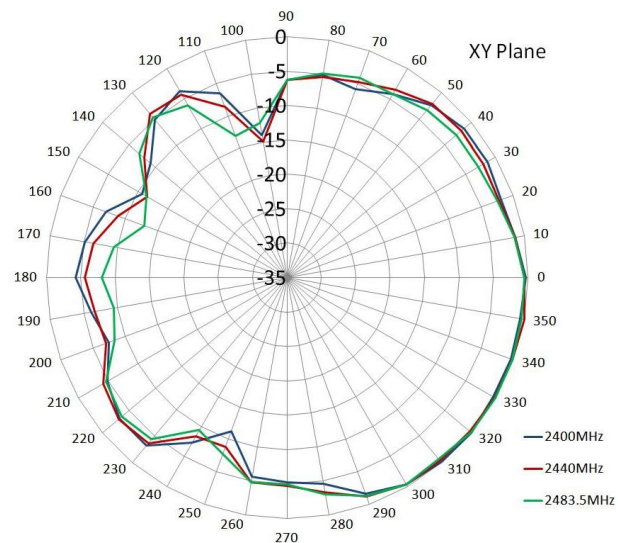



Jinchang Electron Global Service

