

GPS+LTE Combination Antenna JCB010L

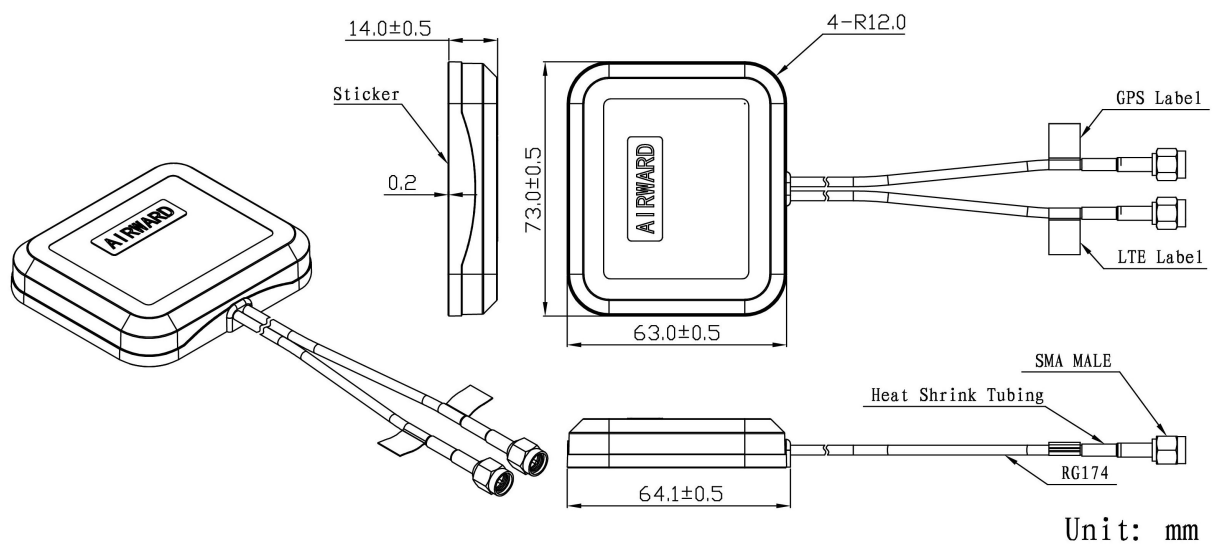

DIMENSIONS



SPECIFICATIONS

Item		Specifications	
GPS Antenna	Dielectric Antenna	Center Frequency	1575.42±3MHz
		Band Width	CF±5MHz
		Polarization	RHCP
		Gain	2dBic (Zenith)
		V.S.W.R	<1.5
		Impedance	50Ω
		Axial Ratio	3dB (max)
	LNA	Gain	28±2dB
		Noise Figure	<1.5dB
		V.S.W.R	<2.0
		Supply Voltage	2.2~5V DC
Current Consumption		<15mA	
LTE Antenna		Frequency Range	698~960MHz/1710~2690MHz
		V.S.W.R (min)	<3.0
		Polarization	Linear
		Gain	2dBi
		Impedance	50Ω
Mechanical		Cable	RG174
		Connector	SMA/MCX/FAKRA or others
		Radome Material	ABS
		Mounting Method	Adhesive/Magnet
Environmental		Operating Temperature	-40℃~+85℃
		Relative Humidity	Up to 95%
		Ingress Protection	IP66
		Vibration	10 to 55Hz with 1.5mm amplitude 2hours
		Environmentally Friendly	ROHS Compliant

Radiation Pattern

GPS Antenna

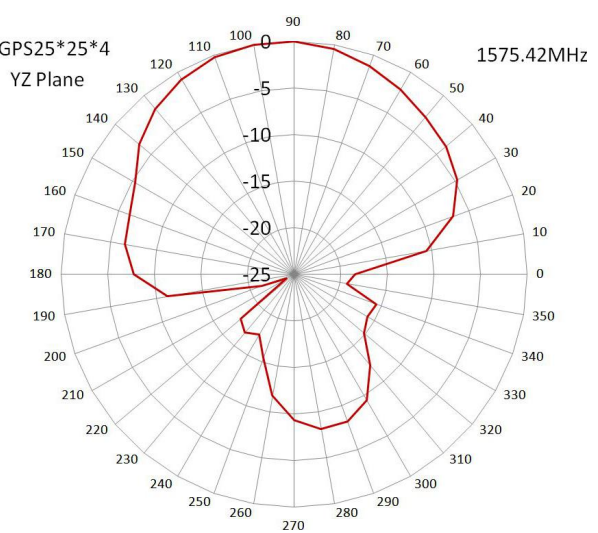
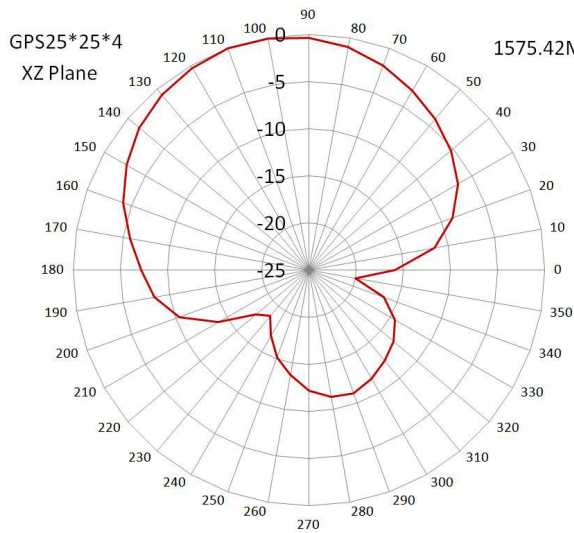
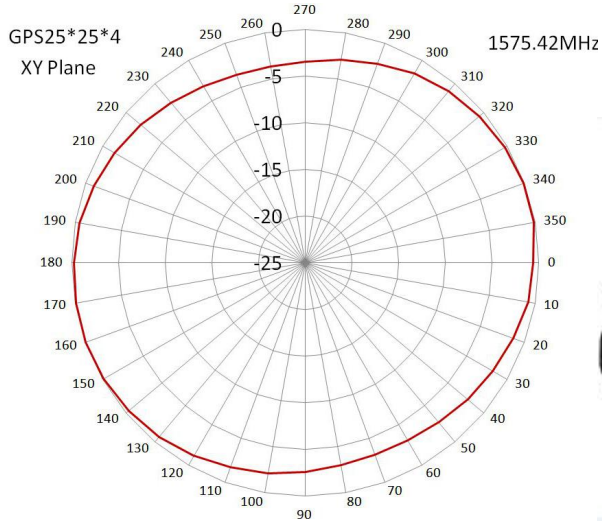

LTE Antenna

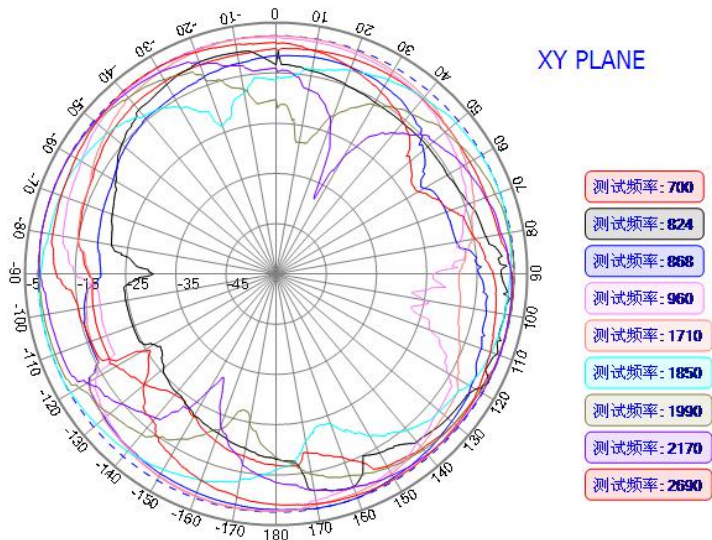



Jinchang Electron Global Service

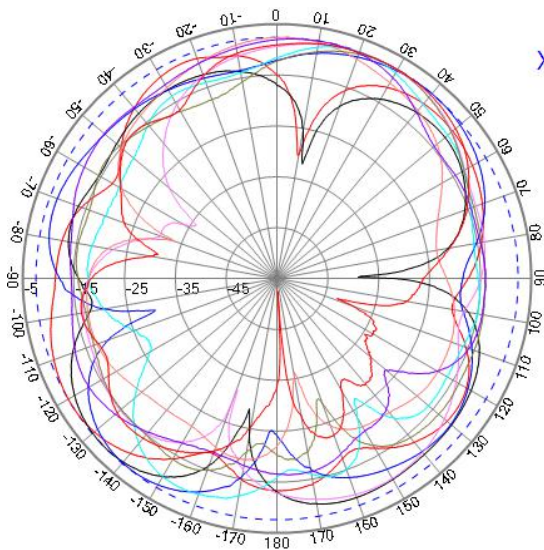

XZ PLANE

- 测试频率: 700
- 测试频率: 824
- 测试频率: 868
- 测试频率: 960
- 测试频率: 1710
- 测试频率: 1850
- 测试频率: 1990
- 测试频率: 2170
- 测试频率: 2690

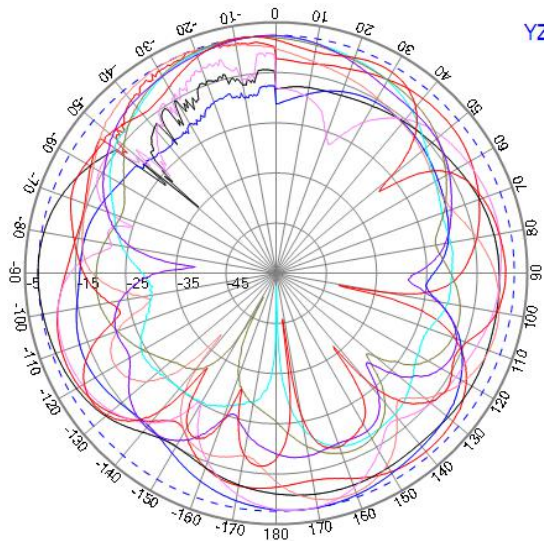

YZ PLANE

- 测试频率: 700
- 测试频率: 824
- 测试频率: 868
- 测试频率: 960
- 测试频率: 1710
- 测试频率: 1850
- 测试频率: 1990
- 测试频率: 2170
- 测试频率: 2690